

Synchronous motor 42S-8 同步电机 42S-8

Technical Data 技术数据

Item	Unit	Frequency	
		50 Hz	60 Hz
Rated speed 额定转速	rpm	375	450
Synchronous torque 同步扭矩	Ncm	3.1	2.95
Delivery of power 输出功率	W	1.22	1.39
Power consumption 功耗	W	3.5	3.9
Rated current (230 V) 额定电流	mA	14.5	16
Operating capacitor 电容	F	0.1	0.1
Max. externally permitted mass moment of inertia 允许的最大外部惯量	gcm ²	45	30
Self-holding torque, typical 自锁扭矩	Ncm	0.5	0.5
Excess winding temperature 绕组温升	K	44	48
Permitted radial force 允许径向力 F_r	N	5	5
Permitted axial force 允许轴向力 F_{as}	N	1.5	1.5
Weight 重量	kg	0.14	
Protection grade 防护等级		IP 41	
Insulation class 绝缘等级		E	
Dielectric strength 介电强度		according to IEC 60034-1	

Ordering code 订货号		100145		100147		100148	
Rated voltage 额定电压	V	230		42		24	
Frequency 频率	Hz	50	60	50	60	50	60
Operating capacitor 电容	F	0.39	0.39	2.5	2.5	7	7
Rated current 额定电流	mA	29	32	71.2	80	120	135

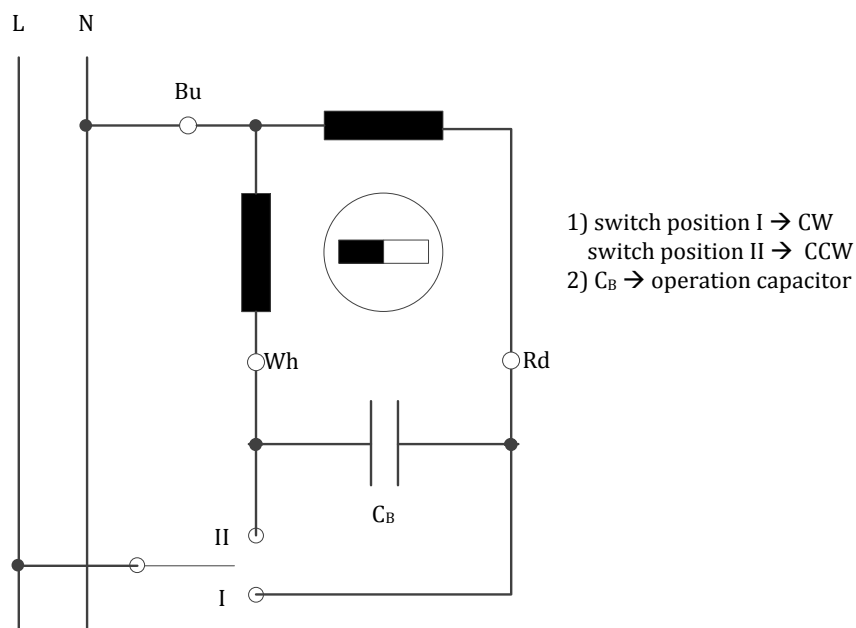

Wiring 42s-8 接线图

Synchronous motor 42S-8 同步电机 42S-8

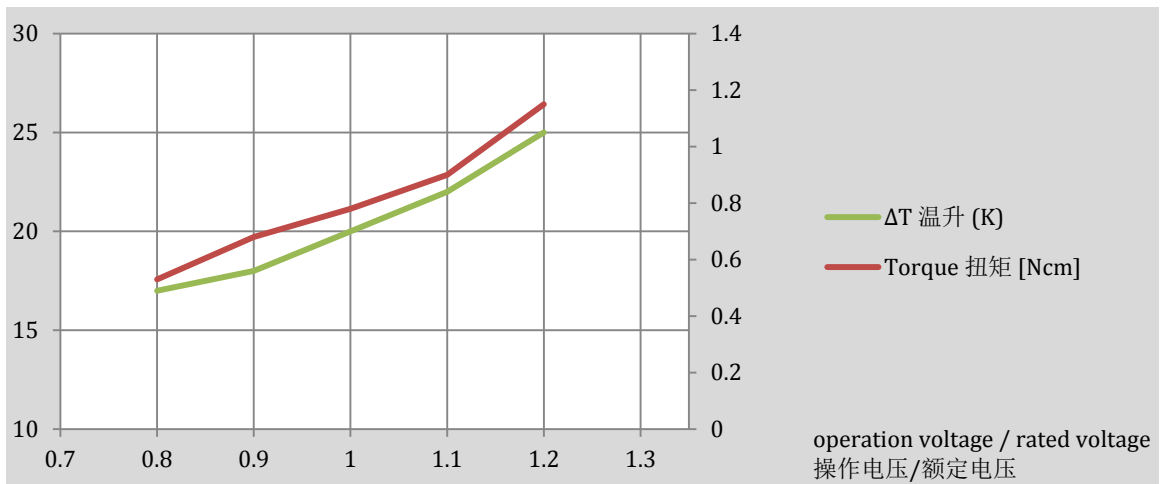

Characteristic curve 42s-8 at 50 Hz 特性曲线@50 Hz

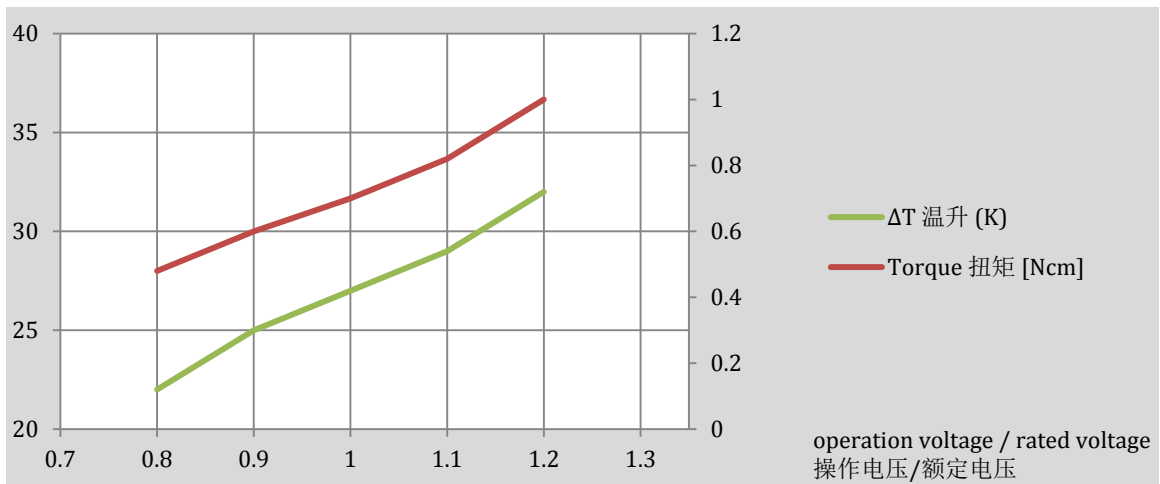

Characteristic curve 42s-8 at 60 Hz 特性曲线@60 Hz

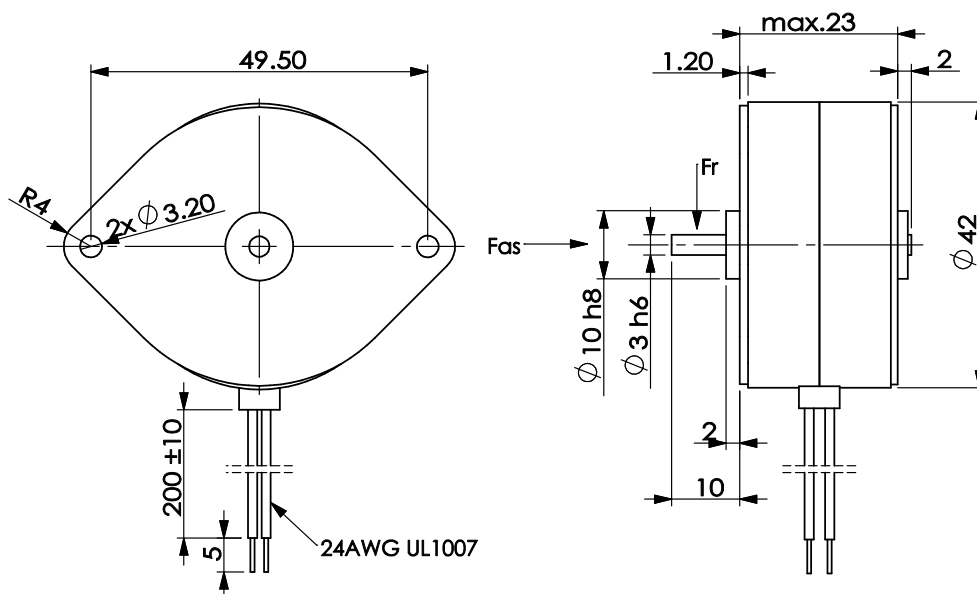

Demension 尺寸图